

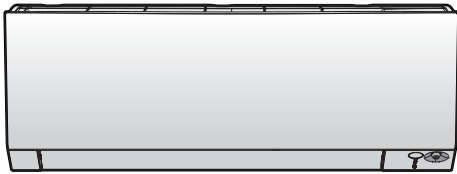

User reference guide

Daikin room air conditioner



CTXM15R2V1B
CTXM15R5V1B

FTXM20R2V1B
FTXM20R5V1B
FTXM25R2V1B
FTXM25R5V1B
FTXM35R2V1B
FTXM35R5V1B
FTXM42R2V1B
FTXM42R5V1B

FTXM50R2V1B
FTXM60R2V1B
FTXM71R2V1B

Table of contents

1	About the documentation	4
1.1	About this document	4
2	General safety precautions	5
2.1	About the documentation	5
2.1.1	Meaning of warnings and symbols	5
3	User safety instructions	7
3.1	General	7
3.2	Instructions for safe operation	8
4	About the system	12
4.1	Indoor unit	12
4.1.1	Indoor unit display	13
4.2	About the user interface	13
4.2.1	Components: User interface	14
4.2.2	Status: User interface LCD	15
4.2.3	To operate the user interface	16
5	Before operation	17
5.1	Overview: Before operation	17
5.2	To insert the batteries	17
5.3	To mount the user interface holder	18
5.4	About the clock	18
5.4.1	To set the clock	18
5.5	Brightness of the indoor unit display	19
5.5.1	To set the brightness of the indoor unit display	19
5.6	To turn on the power supply	19
6	Operation	20
6.1	Operation range	20
6.2	When to use which feature	20
6.3	Operation mode and temperature setpoint	22
6.3.1	To start/stop operation mode and to set the temperature	22
6.4	Airflow rate	23
6.4.1	To adjust the airflow rate	23
6.5	Airflow direction	23
6.5.1	To adjust vertical airflow direction	24
6.5.2	To adjust horizontal airflow direction	24
6.5.3	To use 3-D airflow direction	24
6.6	Comfort airflow and Intelligent eye operation	25
6.6.1	Comfort airflow operation	25
6.6.2	Intelligent eye operation	25
6.6.3	To start/stop Comfort and Intelligent eye operation	26
6.7	Powerful operation	26
6.7.1	To start/stop Powerful operation	27
6.8	Econo and Outdoor unit quiet operation	27
6.8.1	Econo operation	27
6.8.2	Outdoor unit quiet operation	27
6.8.3	To start/stop Econo and Outdoor unit quiet operation	28
6.9	Flash Streamer (air cleaning) operation	28
6.9.1	To start/stop Flash Streamer (air cleaning) operation	28
6.10	OFF/ON timer operation	29
6.10.1	To start/stop OFF timer operation	29
6.10.2	To start/stop ON timer operation	30
6.10.3	To combine OFF timer and ON timer	30
6.11	Weekly timer operation	30
6.11.1	To set Weekly timer operation	31
6.11.2	To copy reservations	32
6.11.3	To confirm reservations	33
6.11.4	To deactivate and reactivate Weekly timer operation	33
6.11.5	To delete reservations	34
6.12	Wireless LAN connection	34
6.12.1	Precautions when using the wireless LAN	35
6.12.2	To install the Daikin Residential Controller application	35
6.12.3	To set the wireless connection	35

6.13	About Multi system.....	38
6.13.1	Priority room setting	38
6.13.2	Night quiet mode.....	39
6.13.3	Cooling/heating mode lock in Multi-system.....	40
7	Energy saving and optimum operation	41
8	Maintenance and service	43
8.1	Overview: Maintenance and service	43
8.2	To clean the indoor unit and user interface.....	44
8.3	To clean the front panel	45
8.4	To remove the front panel.....	45
8.5	About the air filters.....	45
8.6	To clean the air filters	45
8.7	To clean the titanium apatite deodorising filter and the silver allergen removal air purifying filter	47
8.8	To replace the titanium apatite deodorising filter and the silver allergen removal air purifying filter	47
8.9	To re-install the front panel.....	48
8.10	To take following items into account before a long idle period.....	48
9	Troubleshooting	50
9.1	Symptoms that are NOT system malfunctions.....	52
9.1.1	Symptom: A sound like water flowing is heard	52
9.1.2	Symptom: A blowing sound is heard.....	52
9.1.3	Symptom: A ticking sound is heard.....	52
9.1.4	Symptom: A whistling sound is heard.....	52
9.1.5	Symptom: A clicking sound during operation or idle time is heard.....	52
9.1.6	Symptom: A clapping sound is heard.....	53
9.1.7	Symptom: White mist comes out of a unit (Indoor unit, outdoor unit).....	53
9.1.8	Symptom: The units can give off odours	53
9.1.9	Symptom: The outdoor fan rotates while the air conditioner is not in operation	53
9.1.10	Symptom: Indoor unit fan speed does not correspond with the setpoint (during low ambient cooling operation in Multi system)	53
9.2	Solving problems based on error codes.....	53
9.3	Troubleshooting for wireless LAN connection	55
10	Disposal	56
11	Glossary	57

1 About the documentation

1.1 About this document

Thank you for purchasing this product. Please:

- Keep the documentation for future reference.

Target audience

End users



INFORMATION

This appliance is intended to be used by expert or trained users in shops, in light industry, and on farms, or for commercial and household use by lay persons.

Documentation set

This document is part of a documentation set. The complete set consists of:

- **General safety precautions:**
 - Safety instructions that you must read before operating your system
 - Format: Paper (in the box of the indoor unit)
- **Operation manual:**
 - Quick guide for basic usage
 - Format: Paper (in the box of the indoor unit)
- **User reference guide:**
 - Detailed step-by-step instructions and background information for basic and advanced usage
 - Format: Digital files on <http://www.daikineurope.com/support-and-manuals/product-information/>

Latest revisions of the supplied documentation may be available on the regional Daikin website or via your installer.

The original documentation is written in English. All other languages are translations.

2 General safety precautions

2.1 About the documentation

- The original documentation is written in English. All other languages are translations.
- The precautions described in this document cover very important topics, follow them carefully.
- The installation of the system, and all activities described in the installation manual and in the installer reference guide **MUST** be performed by an authorised installer.

2.1.1 Meaning of warnings and symbols



DANGER

Indicates a situation that results in death or serious injury.



DANGER: RISK OF ELECTROCUTION

Indicates a situation that could result in electrocution.



DANGER: RISK OF BURNING/SCALDING

Indicates a situation that could result in burning/scalding because of extreme hot or cold temperatures.



DANGER: RISK OF EXPLOSION

Indicates a situation that could result in explosion.



WARNING

Indicates a situation that could result in death or serious injury.



WARNING: FLAMMABLE MATERIAL



CAUTION

Indicates a situation that could result in minor or moderate injury.



NOTICE





Indicates a situation that could result in equipment or property damage.





INFORMATION

Indicates useful tips or additional information.

Symbols used on the unit:

Symbol	Explanation
	Before installation, read the installation and operation manual, and the wiring instruction sheet.
	Before performing maintenance and service tasks, read the service manual.
	For more information, see the installer and user reference guide.
	The unit contains rotating parts. Be careful when servicing or inspecting the unit.

Symbols used in the documentation:

Symbol	Explanation
	Indicates a figure title or a reference to it. Example: "▲ 1-3 Figure title" means "Figure 3 in chapter 1".
	Indicates a table title or a reference to it. Example: "■ 1-3 Table title" means "Table 3 in chapter 1".

3 User safety instructions

Always observe the following safety instructions and regulations.

3.1 General



WARNING

If you are NOT sure how to operate the unit, contact your installer.



WARNING

This appliance is not intended for use by persons, including children, with reduced physical, sensory or mental capabilities, or lack of experience and knowledge, unless they have been given supervision or instruction concerning use of the appliance by a person responsible for their safety.

Children should be supervised to ensure that they do not play with the appliance.

Cleaning and user maintenance must not be carried out by children without supervision.



WARNING

To prevent electrical shocks or fire:

- Do NOT rinse the unit.
- Do NOT operate the unit with wet hands.
- Do NOT place any objects containing water on the unit.



CAUTION

- Do NOT place any objects or equipment on top of the unit.
- Do NOT sit, climb or stand on the unit.

- Units are marked with the following symbol:



This means that electrical and electronic products may NOT be mixed with unsorted household waste. Do NOT try to dismantle the system yourself: the dismantling of the system, treatment of the refrigerant, of oil and of other parts must be done by an authorized installer and must comply with applicable legislation.

Units must be treated at a specialized treatment facility for reuse, recycling and recovery. By ensuring this product is disposed of correctly, you will help to prevent potential negative consequences for the environment and human health. For more information, contact your installer or local authority.

- Batteries are marked with the following symbol:



This means that the batteries may NOT be mixed with unsorted household waste. If a chemical symbol is printed beneath the symbol, this chemical symbol means that the battery contains a heavy metal above a certain concentration.

Possible chemical symbols are: Pb: lead (>0.004%).

Waste batteries must be treated at a specialized treatment facility for reuse. By ensuring waste batteries are disposed of correctly, you will help to prevent potential negative consequences for the environment and human health.

3.2 Instructions for safe operation



WARNING: MILDLY FLAMMABLE MATERIAL

The refrigerant inside this unit is mildly flammable.



CAUTION

The indoor unit contains radio equipment, minimum separation distance between the radiating part of the equipment and the user is 10 cm.



CAUTION

Do NOT insert fingers, rods or other objects into the air inlet or outlet. When the fan is rotating at high speed, it will cause injury.

**WARNING**

- Do NOT modify, disassemble, remove, reinstall or repair the unit yourself as incorrect dismantling or installation may cause an electric shock or fire. Contact your dealer.
- In case of accidental refrigerant leaks, make sure there are no naked flames. The refrigerant itself is entirely safe, non-toxic and mildly flammable, but it will generate toxic gas when it accidentally leaks into a room where combustible air from fan heaters, gas cookers, etc. is present. Always have qualified service personnel confirm that the point of leakage has been repaired or corrected before resuming operation.

**CAUTION**

ALWAYS use a user interface to adjust the position of the flaps and louvers. When the flaps and louvers are swinging and you move them forcibly by hand, the mechanism will break.

**CAUTION**

NEVER expose little children, plants or animals directly to the airflow.

**WARNING**

Do NOT place objects below the indoor and/or outdoor unit that may get wet. Otherwise condensation on the unit or refrigerant pipes, air filter dirt or drain blockage may cause dripping, and objects under the unit may get dirty or damaged.

**WARNING**

Do NOT place a flammable spray bottle near the air conditioner and do NOT use sprays near the unit. Doing so may result in a fire.

**CAUTION**

Do NOT operate the system when using a room fumigation-type insecticide. Chemicals could collect in the unit, and endanger the health of people who are hypersensitive to chemicals.



WARNING

The refrigerant inside the unit is mildly flammable, but normally does NOT leak. If the refrigerant leaks in the room and comes in contact with fire from a burner, a heater, or a cooker, this may result in fire, or the formation of a harmful gas.

Turn off any combustible heating devices, ventilate the room, and contact the dealer where you purchased the unit.

Do NOT use the unit until a service person confirms that the part from which the refrigerant leaked has been repaired.



WARNING

- Do NOT pierce or burn refrigerant cycle parts.
- Do NOT use cleaning materials or means to accelerate the defrosting process other than those recommended by the manufacturer.
- Be aware that the refrigerant inside the system is odourless.



WARNING

The appliance shall be stored in a room without continuously operating ignition sources (example: open flames, an operating gas appliance or an operating electric heater).



DANGER: RISK OF ELECTROCUTION

To clean the air conditioner or air filter, be sure to stop operation and turn all power supplies off. Otherwise, an electric shock and injury may result.



CAUTION

After a long use, check the unit stand and fitting for damage. If damaged, the unit may fall and result in injury.



CAUTION

Do NOT touch the heat exchanger fins. These fins are sharp and could result in cutting injuries.



WARNING

Be careful with ladders when working in high places.

**WARNING**

Improper detergents or cleaning procedure may cause damage on plastic components or water leakage. Splashed detergent on electric components, such as motors, may cause failure, smoke or ignition.

**DANGER: RISK OF ELECTROCUTION**

Before cleaning, be sure to stop the operation, turn the breaker off or pull out the supply cord. Otherwise, an electric shock and injury may result.

**WARNING**

Stop operation and shut off the power if anything unusual occurs (burning smells etc.).

Leaving the unit running under such circumstances may cause breakage, electric shock or fire. Contact your dealer.

4 About the system



WARNING: MILDLY FLAMMABLE MATERIAL

The refrigerant inside this unit is mildly flammable.



CAUTION

The indoor unit contains radio equipment, minimum separation distance between the radiating part of the equipment and the user is 10 cm.



NOTICE

Do NOT use the system for other purposes. In order to avoid any quality deterioration, do NOT use the unit for cooling precision instruments, food, plants, animals, or works of art.

4.1 Indoor unit



CAUTION

Do NOT insert fingers, rods or other objects into the air inlet or outlet. When the fan is rotating at high speed, it will cause injury.



INFORMATION

The sound pressure level is less than 70 dBA.



WARNING

- Do NOT modify, disassemble, remove, reinstall or repair the unit yourself as incorrect dismantling or installation may cause an electric shock or fire. Contact your dealer.
- In case of accidental refrigerant leaks, make sure there are no naked flames. The refrigerant itself is entirely safe, non-toxic and mildly flammable, but it will generate toxic gas when it accidentally leaks into a room where combustible air from fan heaters, gas cookers, etc. is present. Always have qualified service personnel confirm that the point of leakage has been repaired or corrected before resuming operation.



INFORMATION

The following figures are just examples and may NOT completely match your system layout.

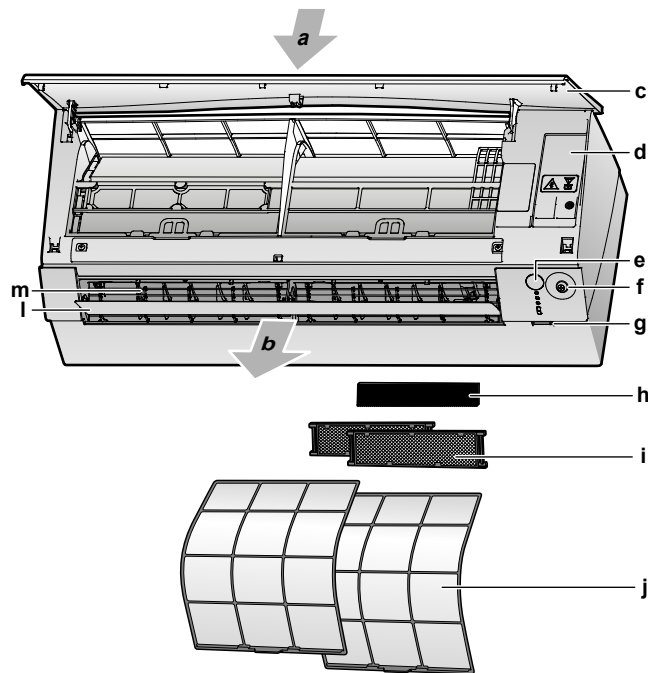

- a Air inlet
- b Air outlet
- c Front panel
- d Service cover
- e Indoor unit display
- f Intelligent eye sensor
- g Room temperature sensor
- h Only for class 15~42: Titanium apatite deodorising filter (without frame)
- i Only for class 50~71: Titanium apatite deodorising filter and silver allergen removal air purifying filter (with frame)
- j Air filter
- k Flaps (horizontal blades)
- l Louvers (vertical blades)

4.1.1 Indoor unit display

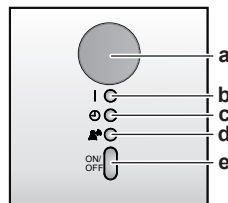

- a Signal receiver for user interface
- b Operation lamp
- c Timer lamp
- d Intelligent eye lamp
- e ON/OFF button

ON/OFF button

If the user interface is missing, you can use the ON/OFF button on the indoor unit to start/stop operation. When operation is started using this button, the following settings are used:

- Operation mode = Automatic
- Temperature setting = 25°C
- Airflow rate = Automatic

4.2 About the user interface

- **Direct sunlight.** Do NOT expose the user interface to direct sunlight.

- **Dust.** Dust on the signal transmitter or receiver will reduce sensitivity. Wipe off dust with a soft cloth.
- **Fluorescent lights.** Signal communication might be disabled if fluorescent lamps are in the room. In that case, contact your installer.
- **Other appliances.** If the user interface signals operate other appliances, move the other appliances, or contact your installer.
- **Curains.** Make sure that the signal between the unit and the user interface is NOT blocked by curtains or other objects.



NOTICE

- Do NOT drop the user interface.
- Do NOT let the user interface get wet.

4.2.1 Components: User interface

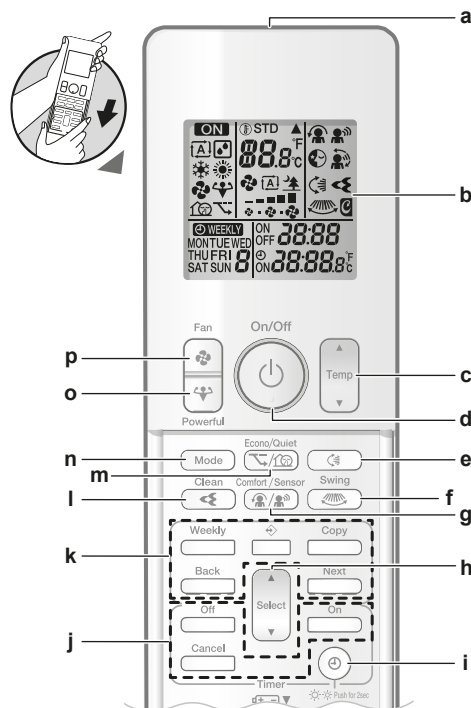





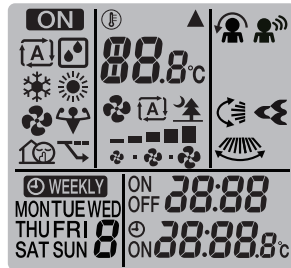

- a Signal transmitter
- b LCD display
- c Temperature adjustment button
- d ON/OFF button
- e Vertical swing button
- f Horizontal swing button
- g Comfort airflow and Intelligent eye operation button
- h Select button
- i Clock and indoor unit display brightness button
- j OFF/ON timer operation buttons
- k Weekly timer operation buttons
- l Flash Streamer (air cleaning) operation button
- m Econo and Outdoor unit quiet operation button
- n Mode button
- o Powerful button
- p Fan button

4.2.2 Status: User interface LCD



Icon	Description
	Operation is active
	Operation mode = Automatic
	Operation mode = Drying
	Operation mode = Heating
	Operation mode = Cooling
	Operation mode = Fan only
	Powerful operation is active
	Econo operation is active
	Outdoor unit quiet operation is active
	The indoor unit receives a signal from the user interface
	Current temperature setting
	Airflow rate = Automatic
	Airflow rate = Indoor unit quiet
	Airflow rate = High
	Airflow rate = Medium high
	Airflow rate = Medium
	Airflow rate = Medium low
	Airflow rate = Low
	Comfort operation is active
	Intelligent eye is active
	Automatic vertical swing is active
	Automatic horizontal swing is active

Icon	Description
	Flash Streamer (air cleaning) is active
	ON timer is active
	OFF timer is active
	Weekly timer is active
	Day of the week
	Current time

4.2.3 To operate the user interface

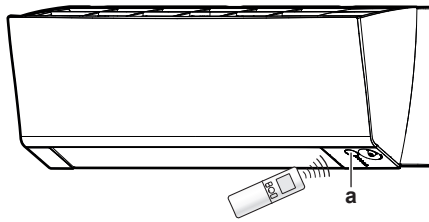

a Signal receiver

- 1 Aim the signal transmitter at the signal receiver on the indoor unit (maximum distance for communication is 7 m).

Result: When the indoor unit receives a signal from the user interface, you will hear a sound:

Sound	Description
Beep-beep	Operation starts.
Beep	Setting changes.
Long beep	Operation stops.

5 Before operation

5.1 Overview: Before operation

This chapter describes what you have to do before operating the unit.

Typical workflow

Before operation usually consist of the following stages:

- Inserting the batteries in the user interface.
- Fixing the user interface to the wall.
- Setting the brightness of the indoor unit display.
- Setting the clock.
- Turning on the power supply.

5.2 To insert the batteries

The batteries will last for about 1 year.

- 1 Remove the front cover.
- 2 Insert both batteries at once.
- 3 Put back the front cover.

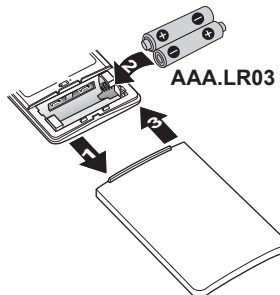

INFORMATION

- Low energy of battery is indicated by flashing of LCD display.
- ALWAYS replace both batteries at once.

5.3 To mount the user interface holder

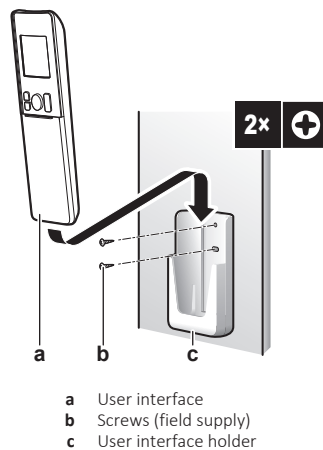

- 1 Choose a place where the signals reach the unit.
- 2 Attach the holder with screws to the wall or a similar location.
- 3 Hang the user interface on the user interface holder.

5.4 About the clock

If the indoor unit's internal clock is NOT set to the correct time, the ON timer, OFF timer and weekly timer will NOT operate correctly. The clock must be set again:

- After a circuit breaker has turned the unit OFF.
- After a power failure.
- After replacing batteries in the user interface.

5.4.1 To set the clock

Note: If the time is NOT set, MON, ⊕, and 0:00 blink.

- 1 Press ⊕.

Result: MON and ⊕ blink

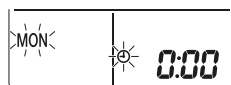

- 2 Press or to set the current day of the week.

Display	Day of the week
MON	Monday
TUE	Tuesday
WED	Wednesday
THU	Thursday
FRI	Friday
SAT	Saturday
SUN	Sunday

- 3 Press ⊕.

Result: ⊕ blinks.

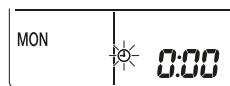

4 Press or to set the correct time.

Note: Holding down or increases or decreases the time setting rapidly.

5 Press .

Result: Setting is complete. blinks.

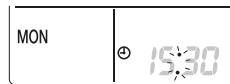

5.5 Brightness of the indoor unit display

Adjust the brightness of the indoor unit display as desired, or turn OFF the display.

5.5.1 To set the brightness of the indoor unit display

1 Keep pressed for at least 2 seconds every time you need to change the setting.

Result: Brightness will be changed in order: high, low, off.

5.6 To turn on the power supply

1 Turn the circuit breaker on.

Result: The flap of the indoor unit will open and close to set the reference position.

6 Operation

6.1 Operation range

Use the system in the following temperature and humidity ranges for safe and effective operation.

In combination with outdoor unit RZAG		
	Cooling and drying^{(a)(b)}	Heating^(a)
Outdoor temperature	–20~52°C DB	–20~24°C DB –21~18°C WB
Indoor temperature	17~38°C DB 12~28°C WB	10~27°C DB
Indoor humidity	≤80% ^(b)	—

^(a) A safety device might stop the operation of the system if the unit runs outside its operation range.

^(b) Condensation and water dripping might occur if the unit runs outside its operation range.

In combination with outdoor units: RXM71R, 2MXM, 3MXM, 4MXM, 5MXM		
	Cooling and drying^{(a)(b)}	Heating^(a)
Outdoor temperature	–10~46°C DB	–15~24°C DB –15~18°C WB
Indoor temperature	18~37°C DB 14~28°C WB	10~30°C DB
Indoor humidity	≤80% ^(b)	—

^(a) A safety device might stop the operation of the system if the unit runs outside its operation range.

^(b) Condensation and water dripping might occur if the unit runs outside its operation range.

In combination with other outdoor units		
	Cooling and drying^{(a)(b)}	Heating^(a)
Outdoor temperature	–10~50°C DB	–20~24°C DB –21~18°C WB
Indoor temperature	18~37°C DB 14~28°C WB	10~30°C DB
Indoor humidity	≤80% ^(b)	—

^(a) A safety device might stop the operation of the system if the unit runs outside its operation range.













^(b) Condensation and water dripping might occur if the unit runs outside its operation range.

6.2 When to use which feature

You can use the following table to determine which features to use:

**INFORMATION**

Operation modes: **cooling**, **drying** and **automatic** are NOT available for the **heating only** version of the product.

Feature	Tasks
Basic features	
 Operation modes and temperature	<p>To start/stop the system and to set the temperature:</p> <ul style="list-style-type: none"> In Heating and Cooling mode, heat up or cool down a room. In Fan only mode, blow air in a room without heating or cooling. In Drying mode, decrease the humidity in a room. In Automatic mode, an appropriate temperature and operation mode is automatically selected.
 +  Airflow direction	To adjust the airflow direction (swing or fixed position).
 Airflow rate	<p>To adjust the amount of air blown into the room.</p> <p>To run more quietly.</p>
Advanced features	
 Flash Streamer	<p>To remove airborne allergens such as pollen, adjuvant substances...</p> <p>To reduce bad odors.</p>
 Econo	<p>To use the system when you are also using other power-consuming appliances.</p> <p>To save energy.</p>
 Outdoor unit quiet	To decrease the noise level of the outdoor unit. Example: At night.
 Comfort	To automatically adjust the airflow direction to cool down or heat up the room more effectively.
 Intelligent eye	<p>To prevent the air from coming in direct contact with people.</p> <p>To save energy when nobody is in the room.</p>
 Powerful	To cool down or heat up the room quickly.
 ON timer +  OFF timer	To automatically turn ON or OFF the system.
 Weekly timer	To automatically turn ON or OFF the system on a weekly basis.
Additional features	
Wireless LAN connection	To operate the unit using smart appliances.

6.3 Operation mode and temperature setpoint

When. Adjust the system operation mode and set the temperature when you want to:





- Heat up or cool down a room
- Blow air in a room without heating or cooling
- Decrease the humidity in a room

What. The system operates differently, depending on the user selection.



INFORMATION

Operation modes: **cooling**, **drying** and **automatic** are NOT available for the **heating only** version of the product.

Setting	Description
 Automatic	The system cools down or heats up a room to the temperature setpoint. It automatically switches between cooling and heating if necessary.
 Drying	The system decreases the humidity in a room.
 Heating	The system heats up a room to the temperature setpoint.
 Cooling	The system cools down a room to the temperature setpoint.
 Fan	The system only controls the airflow (airflow rate and airflow direction). The system does NOT control the temperature.

Additional info:

- **Outside temperature.** The system's cooling or heating effect decreases when the outside temperature is too high or too low.
- **Defrost operation.** During heating operation, frost might occur on the outdoor unit and decrease the heating capacity. In that case, the system automatically switches to defrosting operation to remove the frost. During defrosting operation, hot air is NOT blown from the indoor unit.

6.3.1 To start/stop operation mode and to set the temperature



ON: Unit is operating.

: Operation mode = Automatic

: Operation mode = Drying

: Operation mode = Cooling

: Operation mode = Heating

: Operation mode = Fan only

: Shows the set temperature.

- 1 Press **Mode** one or more times to select the operation mode.

Result: The mode will be set as follows:



2 Press to **start** operation.

Result: and the selected mode are displayed on the LCD.

3 Press or one or more times to lower or raise the **temperature**.

Cooling operation	Heating operation	Automatic operation	Drying or Fan only operation
18~32°C	10~30°C	18~30°C	—

Note: When using **drying** or **fan only** mode, you cannot adjust the temperature.

4 Press to **stop** operation.

Result: disappears from the LCD. The operation lamp goes off.

6.4 Airflow rate

1 Press to choose:

	5 airflow rate levels, from "■" to "■■■■"
	Automatic airflow rate operation
	Indoor unit quiet operation. When the airflow rate is set to "■", the noise from the unit will be reduced.



INFORMATION

- If the unit reaches the temperature setpoint in cooling or heating mode, the fan will stop operating.
- When using drying operation mode, you CANNOT adjust the airflow rate setting.

6.4.1 To adjust the airflow rate

1 Press to change the airflow setting as follows:



6.5 Airflow direction

When. Adjust the airflow direction as desired.

What. The system directs the airflow differently, depending on the user selection (swinging or fixed position). It does so by moving horizontal blades (flaps) or vertical blades (louvers).

Setting	Airflow direction
Vertical automatic swing	Moves up and down.
Horizontal automatic swing	Moves from side to side.
3-D airflow direction	Moves alternately up and down and from side to side

Setting	Airflow direction
[—]	Stays in a fixed position.

**CAUTION**

ALWAYS use a user interface to adjust the position of the flaps and louvers. When the flaps and louvers are swinging and you move them forcibly by hand, the mechanism will break.

The movable range of the flap varies according to the operation mode. The flap will stop at the upper position when the airflow rate is changed to low during the up and down swing setting.

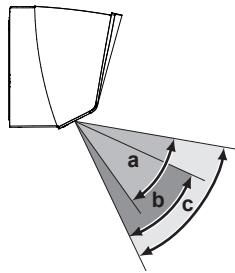

- a Flap range in cooling or drying operation
- b Flap range in heating operation
- c Flap range in fan only operation

6.5.1 To adjust vertical airflow direction

- 1 Press .

Result: appears on the LCD. The flaps (horizontal blades) will begin to swing.

- 2 To use fixed position, press when the flaps reach the desired position.

Result: disappears from the LCD. The flaps will stop moving.

6.5.2 To adjust horizontal airflow direction

- 1 Press .

Result: appears on the LCD. The louvers (vertical blades) will begin to swing.

- 2 To use fixed position, press when the louvers reach the desired position.

Result: disappears from the LCD. The louvers will stop moving.



**INFORMATION**



When the unit is installed in a corner of a room, the direction of the louvers should be facing away from the wall. Efficiency will drop if a wall blocks the air.

6.5.3 To use 3-D airflow direction

- 1 Press and .

Result: and appear on the LCD. The flaps (horizontal blades) and louvers (vertical blades) will begin to swing.

- 2 To use fixed position, press  and  when the flaps and louvers reach the desired position.

Result:  and  disappear from the LCD. The flaps and the louvers will stop moving.

6.6 Comfort airflow and Intelligent eye operation

You can use Comfort and Intelligent eye operation separately, or combine them.

6.6.1 Comfort airflow operation

This operation can be used in **heating** or **cooling** operation mode. It will provide a comfortable wind that will NOT come in direct contact with people. The system automatically sets the fixed airflow position upward in Cooling and downward in Heating operation mode.

Cooling operation mode

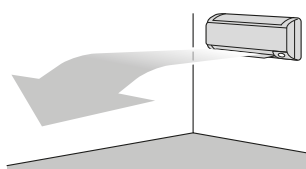

Heating operation mode

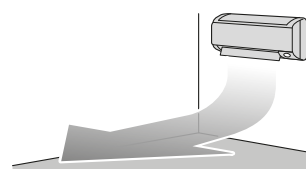

INFORMATION

Powerful and Comfort airflow operation CANNOT be used at the same time. The last selected function takes priority. If the vertical automatic swing is selected, Comfort airflow operation will be cancelled.

6.6.2 Intelligent eye operation

The system detects movement in the room and automatically adjusts the airflow direction and temperature in order to avoid direct contact with people. If no movement is detected for 20 minutes, the system switches to energy saving operation:

Operation	Energy saving operation
Heating	Temperature is lowered by 2°C.
Cooling and drying	If the temperature in the room is: <ul style="list-style-type: none"> ▪ <30°C, the temperature is raised by 2°C ▪ ≥30°C, the temperature is raised by 1°C
Fan only	Decreases airflow rate.

About the Intelligent eye sensor



NOTICE

- Do NOT hit or push the Intelligent eye sensor. Doing so may lead to malfunction.
- Do NOT place large objects near the Intelligent eye sensor.



INFORMATION

Powerful or Night set operation CANNOT be used at the same time with Intelligent eye operation. The last selected function takes priority.

- **Detection range.** Up to 7 m.

Vertical angle (side view)

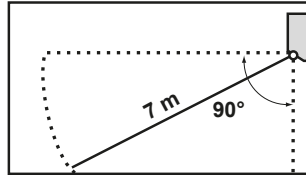

Horizontal angle (top view)

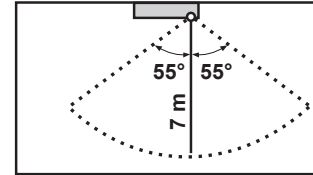



- **Detection sensitivity.** Changes according to location, the number of persons in the room, temperature range, etc.
- **Detection mistakes.** The sensor may mistakenly detect pets, sunlight, moving curtains, etc.

6.6.3 To start/stop Comfort and Intelligent eye operation

- 1 Press  one or more times.

Result: The setting will change as follows:



Display	Operation
	Comfort airflow
	Intelligent eye
	Comfort airflow and Intelligent eye
—	Both deactivated

Note: If there are people close to the front of the indoor unit or there are too many people, use both operations at the same time.

- 2 To stop operation, press  until both symbols disappear from the LCD.

6.7 Powerful operation

This operation quickly maximizes the cooling/heating effect in any operation mode. You can get the maximum capacity.

Mode	Airflow rate
Cooling/Heating	<ul style="list-style-type: none"> ▪ To maximize the cooling/heating effect, the capacity of outdoor unit is increased. ▪ The airflow rate is fixed to the maximum setting. ▪ The temperature and airflow settings CANNOT be changed.

Mode	Airflow rate
Drying	<ul style="list-style-type: none"> The temperature setting is lowered by 2.5°C. The airflow rate is slightly increased.
Fan only	The airflow rate is fixed to the maximum setting.



INFORMATION

Powerful operation CANNOT be used together with Econo, Comfort airflow, Intelligent eye and Outdoor unit quiet operation. The last selected function takes priority.

Powerful operation will NOT increase the capacity of the unit if it already operates at maximum capacity.

6.7.1 To start/stop Powerful operation

- 1 Press to start.

Result: is displayed on the LCD. Powerful operation runs for 20 minutes; after that, operation returns to the previously set mode.

- 2 Press to stop.

Result: disappears from the LCD.

Note: Powerful operation can be set only when the unit is running. If you press or if you change operation mode, operation will be cancelled; disappears from the LCD.

6.8 Econo and Outdoor unit quiet operation

6.8.1 Econo operation

This is a function which enables efficient operation by limiting the maximum power consumption value. This function is useful for cases in which attention should be paid to ensure a circuit breaker will not trip when the product runs alongside other appliances.



INFORMATION

- Powerful and Econo operation CANNOT be used at the same time. The last selected function takes priority.
- Econo operation reduces power consumption of the outdoor unit by limiting the rotation speed of the compressor. If power consumption is already low, Econo operation will NOT further reduce power consumption.

6.8.2 Outdoor unit quiet operation

Use Outdoor unit quiet operation when you want to decrease the noise level of the outdoor unit. **Example:** At night.

**INFORMATION**

- Powerful and Outdoor unit quiet operation CANNOT be used at the same time. The last selected function takes priority.
- This function is only available in Automatic, Cooling, and Heating operation.
- Outdoor unit quiet operation limits the rotation speed of the compressor. If the rotation speed of compressor is already low, Outdoor unit quiet operation will NOT further reduce the compressor rotation speed.

6.8.3 To start/stop Econo and Outdoor unit quiet operation

- 1 Press one or more times.

Result: The setting will change as follows.



Display	Operation
	Econo
	Outdoor unit quiet
	Econo and Outdoor unit quiet
—	Both deactivated

- 2 To stop operation, press until both symbols disappear from the LCD.

Note: Econo operation can be only set when the unit is running. Pressing cancels the setting and disappears from the LCD.

Note: remains on the LCD, even if you turn off the unit using the user interface or indoor unit ON/OFF switch.

6.9 Flash Streamer (air cleaning) operation

Streamer generates a high-speed electron stream with a high oxidizing power, reducing bad odours. Together with the titanium apatite deodorising filter, silver allergen removal air purifying filter and the air filters, this function cleans the air in the room.

**INFORMATION**

- The high-speed electrons are generated and go away inside the unit to ensure safe operation.
- The Streamer discharge may generate a fizzing sound.
- If the airflow becomes weak, the Streamer discharge may stop temporarily to prevent ozone smell.

6.9.1 To start/stop Flash Streamer (air cleaning) operation

Prerequisite: Make sure the unit is operating (is displayed on the user interface LCD).

- 1 Press .

Result: is displayed on the LCD and the air in the room is cleaned when the unit is operating.

- 2 To stop operation, press .

Result:  disappears from the LCD and operation stops.

6.10 OFF/ON timer operation

Timer functions are useful for automatically switching the air conditioner off/on at night or in the morning. You can also use OFF timer and ON timer in combination.



INFORMATION

Program the timer again in case of:

- A breaker has turned the unit off.
- A power failure.
- After replacing batteries in the user interface.



INFORMATION



The clock MUST be set correctly before using any timer functions. Refer to ["5.4.1 To set the clock" \[▶ 18\]](#).

6.10.1 To start/stop OFF timer operation

- 1 Press  to start.

Result:  is displayed on the LCD and OFF blinks.  and the day of the week disappear from the LCD.





- 2 Press  or  to change the time setting.
3 Press  again.

Result: OFF and the set time are displayed on the LCD.



Result: The timer lamp lights up.



INFORMATION

Each time  or  is pressed, the time setting advances by 10 minutes. Holding the button down will change the setting rapidly.

- 4 To stop operation, press .

Result:  and OFF disappear from the LCD and the timer lamp goes off.  and the day of the week are displayed on the LCD.



INFORMATION

When you set the ON/OFF timer, the time setting is stored in the memory. The memory will be reset when the user interface batteries are replaced.

Use of night set mode in combination with OFF timer

The air conditioner automatically adjusts the temperature setting (0.5°C up in cooling, 2.0°C down in heating) to prevent excessive cooling/heating and ensure a comfortable sleeping temperature.

6.10.2 To start/stop ON timer operation

1 Press **On** to start.

Result: **6:00** is displayed on the LCD and **ON** blinks. ☉ and the day of the week disappear from the LCD.



2 Press **Select** or **Select** to change the time setting.

3 Press **On** again.

Result: **ON** and the set time are displayed on the LCD. The timer lamp lights up.

i **INFORMATION**

Each time **Select** or **Select** is pressed, the time setting advances by 10 minutes. Holding the button down will change the setting rapidly.

4 To stop operation, press **Cancel**.

Result: **6:00** and **ON** disappear from the LCD and the timer lamp goes off. ☉ and the day of the week are displayed on the LCD.

6.10.3 To combine OFF timer and ON timer

1 To set the timers, refer to "6.10.1 To start/stop OFF timer operation" [▶ 29] and "6.10.2 To start/stop ON timer operation" [▶ 30].

Result: **OFF** and **ON** are displayed on the LCD.

Example:

Display	Current time	Set while...	Operation
	6:00	the unit is operating.	Stops at 7:00 and starts at 14:00.
		the unit is NOT operating.	Starts at 14:00.

Note: If the timer setting is active, the current time is NOT displayed on the LCD.

6.11 Weekly timer operation

With this operation, you can save up to 4 timer settings for each day of the week.

Example: Create a different setting from Monday to Friday and a different setting for weekends.

Day of the week	Setting example
<p>Monday</p> <ul style="list-style-type: none"> Make up to 4 settings. 	
<p>Tuesday~Friday</p> <ul style="list-style-type: none"> Use the copy mode if the settings are the same as for Monday. 	

Day of the week	Setting example
Saturday ▪ No timer setting	—
Sunday ▪ Make up to 4 settings.	

- **ON-ON-ON-ON setting.** Enables scheduling the operation mode and set temperature.
- **OFF-OFF-OFF-OFF setting.** Only the turn off time can be set for each day.

Note: Be sure to aim the user interface at the indoor unit and check for a receiving tone when setting the Weekly timer operation.



INFORMATION

The clock **MUST** be set correctly before using any timer functions. Refer to "5.4.1 To set the clock" [▶ 18].



INFORMATION

- Weekly timer and OFF/ON timer operation **CANNOT** be used at the same time. The OFF/ON timer operation takes priority. Weekly timer will be in standby, **WEEKLY** disappears from the LCD. When the OFF/ON timer is completed, the Weekly timer becomes active.
- The day of the week, OFF/ON timer mode, time and temperature (only for ON timer) can be set with the Weekly timer. Other settings are based on previous ON timer setting.

6.11.1 To set Weekly timer operation

- 1 Press

Result: The day of the week and the reservation number of the current day are displayed.



- 2 Press or to select the day of the week and the reservation number.
- 3 Press .

Result: The day of the week is set. **WEEKLY** and ON blink.



- 4 Press or to select the mode.

Result: The setting will change as follows:



Display	Feature
ON	ON timer
OFF	OFF timer
Blank	Deletes reservation

5 Press **Next**.

Result: The OFF/ON timer mode is set. **WEEKLY** and the time blink.



Note: Press **Back** to return to the previous screen. If blank is selected, continue to step 9.

6 Press **Select** or **Select** to select the time. The time can be set between 0:00~23:50 in 10-minute intervals.

7 Press **Next**.

Result: The time is set and **WEEKLY** and the temperature blink.



Note: Press **Back** to return to the previous screen. If OFF timer is selected, continue to step 9.

8 Press **Select** or **Select** to select the desired temperature.

Note: The set temperature for the weekly timer is displayed only when setting the weekly timer mode.



INFORMATION

The temperature can be set between 10~32°C on the user interface, however:

- in cooling and automatic operation mode, the unit will operate at minimum 18°C even if is set at 10~17°C;
- in heating and automatic operation mode, the unit will operate at maximum 30°C even if is set at 31~32°C.

9 Press **Next**.

Result: The temperature and time are set for the ON timer. The time is set for the OFF timer. The timer lamp lights orange.

Result: A new reservation screen will appear.

10 Repeat the previous procedure to set another reservation or press **Exit** to complete the setting.

Result: **WEEKLY** is displayed on the LCD.

Note: A reservation can be copied with the same settings to another day. Refer to "6.11.2 To copy reservations" [▶ 32].

6.11.2 To copy reservations

A reservation can be copied to another day. The complete reservation of the selected day of the week will be copied.

1 Press **Exit**.

2 Press **Select** or **Select** to select the day of the week to be copied.

3 Press **Copy**.

Result: The reservation of the selected day of the week will be copied.



- 4 Press or to select the destination day.
- 5 Press .

Result: The whole reservation is copied to the selected day and the timer lamp lights orange.

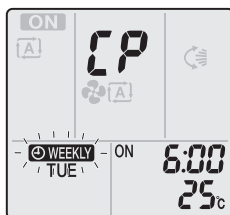

Note: To copy to another day, repeat the procedure.

- 6 Press to complete the setting.

Result: WEEKLY is displayed on the LCD.

Note: To change the reservation setting after copying, refer to ["6.11.1 To set Weekly timer operation"](#) [▶ 31].

6.11.3 To confirm reservations

You can confirm if all reservations are set to your needs.

- 1 Press .

Result: The day of the week and the reservation number of the current day are displayed.



- 2 Press or to select the day of the week and reservation number to be confirmed and check the reservation details.

Note: To change the reservation setting, refer to ["6.11.1 To set Weekly timer operation"](#) [▶ 31].

- 3 Press to exit the confirmation mode.

6.11.4 To deactivate and reactivate Weekly timer operation

- 1 To deactivate the Weekly timer, press while WEEKLY is displayed on the LCD.

Result: WEEKLY disappears from the LCD and the timer lamp goes off.

- 2 To reactivate the Weekly timer, press again.

Result: The last set reservation mode will be used.

6.11.5 To delete reservations

To delete individual reservations

Use this function if you want to delete a single reservation setting.

- 1 Press .

Result: The day of the week and the reservation number are displayed.

- 2 Press  or  to select the day of the week to be deleted.

- 3 Press .

Result: , ON, and OFF blink.

- 4 Press  or  and select "blank".

Result: The setting will change as follows:



- 5 Press .

Result: The selected reservation is deleted.

- 6 Press .

Result: Remaining reservations are active.

To delete a reservation for each day of the week

Use this function if you want to delete all reservation settings for one day of the week. This can be used in confirmation or setting mode.

- 1 Press .

- 2 Press  or  to select the day of the week to be deleted.

- 3 Hold  for about 5 seconds.

Result: All reservations for the selected day are deleted.

- 4 Press .

Result: Remaining reservations are active.

To delete all reservations

Use this function if you want to delete all reservations for all days of the week in one go. This procedure CANNOT be used in the setting mode.

- 1 Hold  for about 5 seconds while in the default display.

Result: All reservations will be deleted.

6.12 Wireless LAN connection

The customer is responsible for providing:

- Smartphone or tablet with minimum supported version of Android or iOS, specified on <http://www.onlinecontroller.daikineurope.com>
- Internet line and communication device, such as a modem, router, etc.
- Wireless LAN access point
- Installed free Daikin Residential Controller application

6.12.1 Precautions when using the wireless LAN

Do NOT use near:

- **Medical equipment.** E.g. persons using cardiac pacemakers or defibrillators. This product may cause electromagnetic interference.
- **Auto-control equipment.** E.g. automatic doors or fire alarm equipment. This product may cause faulty behaviour of the equipment.
- **Microwave oven.** It may affect wireless LAN communications.

6.12.2 To install the Daikin Residential Controller application

- 1 Open:
 - Google Play for appliances using Android.
 - App Store for appliances using iOS.
- 2 Search for Daikin Residential Controller.
- 3 Follow the directions on the screen to install.

6.12.3 To set the wireless connection

There are two options to connect the wireless adapter with your smart device.

- **Connect the wireless LAN to your smart device directly.**
- **Connect the wireless LAN to your home network.** The wireless LAN will communicate with your smart device in your home network using a modem, router or a similar device.

For more information and FAQ refer to:

<http://www.onlinecontroller.daikineurope.com/>.

- 1 Stop operation before setting the wireless connection.
- 2 Use the user interface to select the wireless LAN setting menu.

Note: Always aim the user interface at the signal receiver on the unit when operating the user interface.

Menu	Description
1	Connection status check
2	WPS connection setting
3	AP mode/RUN mode (SSID + KEY) connection setting
R	Reset to factory default
OFF	Wireless LAN OFF

To confirm the wireless LAN connection status

- 1 On home screen menu, press and hold  for at least 5 seconds while the unit is not operating.

Result: The SP (wireless connection setting menu) appears. 1 is blinking.

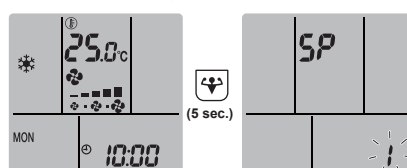

- Press  to confirm the selection.

Result: **!** is blinking.

- Check the operation and timer LEDs on the indoor unit display.

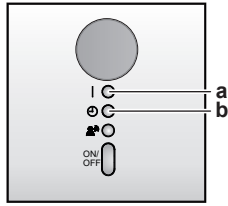

a Operation LED
b Timer LED

If operation LED...	...and timer LED...	...then wireless LAN is...
blinks	blinks	not connected
is off	blinks in 0.5 second interval	running and ready to connect to the home network via WPS button on the router.
is off	blinks in 1 second interval	<ul style="list-style-type: none"> connected to the home network via SSID + KEY. or <ul style="list-style-type: none"> connected to the home network via WPS button on the router.

- Press **Cancel** to exit the menu.

Result: The display will return to the default screen.

To connect the wireless LAN to your home network

The wireless adapter can be connected to your home network using the:

- **WPS** button on the router (if present),
- **SSID** and **KEY** number located on the unit.

To connect using the WPS button

- On home screen menu, hold  for at least 5 seconds while the unit is not operating.

Result: The SP menu **!** appears. **!** is blinking.

- Change to the SP menu **?** by pressing  once or  repeatedly.

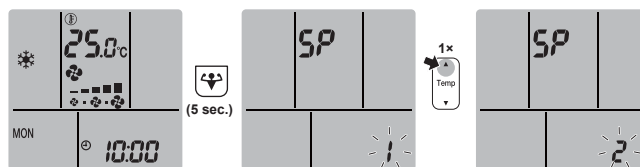

- Press  to confirm the selection.

Result: **?** is blinking. The timer LED is blinking in 0.5 s interval and the operation LED is off.

- Press the WPS button on your communication device (e.g. router) within approximately 1 minute. Refer to the manual of your communication device.

Result: If the connection to your communication device is successful, the timer LED is blinking in 1.0 s interval and the operation LED is off.

**INFORMATION**

If the connection with your router is not possible, try procedure "[To connect using SSID and KEY number](#)" [▶ 37].

- 5 Press **Cancel** to exit the menu.

Result: The display will return to the default screen.

To connect using SSID and KEY number

- 1 On home screen menu, hold  for at least 5 seconds while the unit is not operating.

Result: The SP menu **!** appears. **!** is blinking.

- 2 Change to the SP menu **3** by pressing  twice or  repeatedly.



- 3 Press  to confirm the selection.

Result: **3** is blinking. The timer LED and operation LED are blinking simultaneously.

- 4 Open the Daikin Residential Controller application on your smart device and follow the steps on the screen.

Result: If the connection to your smart device is successful, the timer LED is blinking in 1.0 s interval and the operation LED is off.

- 5 Press **Cancel** to exit the menu.

Result: The display will return to the default screen.

To reset the connection setting to the factory default

Reset the connection setting to the factory default in case you want to:

- disconnect the wireless LAN and the communication device (e.g. router) or smart device,
- repeat the setting if the connection was unsuccessful.

- 1 On home screen menu, hold  for at least 5 seconds while the unit is not operating.

Result: The SP menu **!** appears. **!** is blinking.

- 2 Change to the SP menu **R** by pressing  twice or  repeatedly.

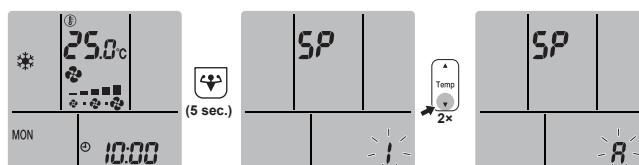

- 3 Hold  for at least 2 seconds to confirm the selection.

Result: **R** is blinking. The operation and timer LEDs are blinking at the same time in 1 s interval. The setting is reset to the factory default.

- 4 Press **Cancel** to exit the menu.

Result: The display will return to the default screen.

To turn off the wireless LAN connection

If you want to turn off the wireless connection function:

- 1 On home screen menu, press  for at least 5 seconds while the unit is not operating.

Result: The SP menu *!* appears. *!* is blinking.

- 2 Change to the SP menu *oFF* by pressing  once or  repeatedly.

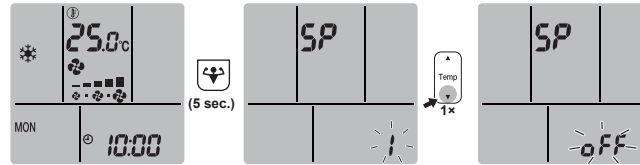

- 3 Hold  for at least 2 seconds to confirm the selection.

Result: *oFF* is blinking. The operation and timer LEDs are blinking alternately in 1 s interval. Communication is OFF.

- 4 Press  to exit the menu.

Result: The display will return to the default screen.

6.13 About Multi system

In Multi system, 1 outdoor unit is connected to multiple indoor units.

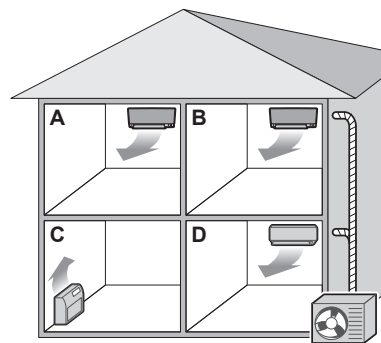

6.13.1 Priority room setting

Priority room setting requires initial programming during installation. Please consult your authorized dealer for assistance.

When priority room setting is inactive or not present

When more than 1 indoor unit is operating, priority is given to the first unit that was turned on. Set other units to the same operation mode. Otherwise, they will enter the standby mode, and the operation lamp will flash (does NOT indicate malfunction).

Exceptions: If the first unit that was turned on is set to **fan only**, and then in the other room **heating** mode is set, priority will be given to the unit set to the heating mode. The first unit will go in standby and the operation lamp will flash.

**INFORMATION**

- The cooling, drying, and fan only operation modes may be used at the same time.
- The automatic operation mode automatically selects cooling or heating, depending on the room temperature and the temperature setting. If the automatic operation mode is selected for all units, all units will operate in the mode of the first unit that was turned on.

Priority when using Outdoor unit quiet operation

Refer to "6.8.2 Outdoor unit quiet operation" [▶ 27].

- 1 Set Outdoor unit quiet operation in all rooms using the user interfaces of the units.
- 2 To cancel Outdoor unit quiet operation, you may stop operation in 1 room using a user interface.
Result: Operation will stop in all rooms. will remain on the display of the other user interfaces.
- 3 To remove the symbol from the other user interfaces, stop Outdoor unit quiet operation in all rooms separately.

Result: The symbol will disappear.

When priority room setting is active

You can select a different operation mode for each room.

Example: Room A has priority, cooling operation mode is selected.

Operation mode in room B, C, D	Status of room B, C and D
Cooling, drying or fan only	Current operation mode maintained
Heating	Standby mode. Operation resumes when room A stops operating.
Automatic	If cooling operation continues. If heating units enter standby mode. Operation resumes when room A stops operating.

Priority when using Powerful operation

Example: Room A has priority. Rooms B, C and D are operating.

- 1 Set Powerful operation in room A.

Result: Capacity in room A is increased. Cooling or heating efficiency in rooms B, C and D may be slightly reduced.

Priority when using Outdoor unit quiet operation

Example: Room A has priority.

- 2 Set Outdoor unit quiet operation on one unit.

Result: All units enter the Outdoor unit quiet operation mode at once.

6.13.2 Night quiet mode

The Night quiet mode requires initial programming during installation. Please consult your dealer for assistance. This mode reduces the operation noise of the outdoor unit during the night by reducing the cooling efficiency.

The Night quiet mode is activated automatically when the temperature drops $\geq 5^{\circ}\text{C}$ below the highest temperature recorded that day.

6.13.3 Cooling/heating mode lock in Multi-system

The cooling/heating mode lock can be set via the Multi outdoor unit. Please consult your authorized dealer for assistance. The cooling/heating mode lock sets the unit forcibly to either cooling or heating operation. Activate this function if you wish to set all indoor units connected in a Multi-system to 1 operation mode.



INFORMATION

The Cooling/heating mode lock CANNOT be activated together with the priority room setting.

7 Energy saving and optimum operation



INFORMATION

- Even if the unit is turned OFF, it consumes electricity.
- When the power turns back on after a power break, the previously selected mode will be resumed.



CAUTION

NEVER expose little children, plants or animals directly to the airflow.



WARNING

Do NOT place objects below the indoor and/or outdoor unit that may get wet. Otherwise condensation on the unit or refrigerant pipes, air filter dirt or drain blockage may cause dripping, and objects under the unit may get dirty or damaged.



WARNING

Do NOT place a flammable spray bottle near the air conditioner and do NOT use sprays near the unit. Doing so may result in a fire.



CAUTION

Do NOT operate the system when using a room fumigation-type insecticide. Chemicals could collect in the unit, and endanger the health of people who are hypersensitive to chemicals.

Observe the following precautions to ensure the system operates properly.

- Prevent direct sunlight from entering a room during cooling operation by using curtains or blinds.
- Make sure the area is well ventilated. Do NOT block any ventilation openings.
- Ventilate often. Extended use requires special attention to ventilation.
- Keep doors and windows closed. If the doors and windows remain open, air will flow out of your room causing a decrease in the cooling or heating effect.
- Be careful NOT to cool or heat too much. To save energy, keep the temperature setting at a moderate level.
- NEVER place objects near the air inlet or the air outlet of the unit. Doing so may cause a reduced heating/cooling effect or stop operation.
- Turn off the main power supply switch to the unit when the unit is NOT used for longer periods of time. If the main power supply switch is on, the unit consumes electricity. Before restarting the unit, turn on the main power supply switch 6 hours before operation to ensure smooth running.
- Condensation may form if the humidity is above 80% or if the drain outlet gets blocked.
- Adjust the room temperature properly for a comfortable environment. Avoid excessive heating or cooling. Notice that it may take some time for the room temperature to reach the set temperature. Consider using the timer setting options.
- Adjust the air flow direction to avoid cool air from gathering on the floor or warm air against the ceiling. (Up during cooling or dry operation to the ceiling and down during heating operation.)

- Avoid direct air flow to room inhabitants.
- Operate the system within the recommended temperature range (26~28°C for cooling and 20~24°C for heating) to save energy.

8 Maintenance and service

8.1 Overview: Maintenance and service

The installer has to perform a yearly maintenance.

About the refrigerant

This product contains fluorinated greenhouse gases. Do NOT vent gases into the atmosphere.

Refrigerant type: R32

Global warming potential (GWP) value: 675



NOTICE

Applicable legislation on **fluorinated greenhouse gases** requires that the refrigerant charge of the unit is indicated both in weight and CO₂ equivalent.

Formula to calculate the quantity in CO₂ equivalent tonnes: GWP value of the refrigerant × total refrigerant charge [in kg] / 1000

Please contact your installer for more information.



WARNING

The refrigerant inside the unit is mildly flammable, but normally does NOT leak. If the refrigerant leaks in the room and comes in contact with fire from a burner, a heater, or a cooker, this may result in fire, or the formation of a harmful gas.

Turn off any combustible heating devices, ventilate the room, and contact the dealer where you purchased the unit.

Do NOT use the unit until a service person confirms that the part from which the refrigerant leaked has been repaired.



WARNING

- Do NOT pierce or burn refrigerant cycle parts.
- Do NOT use cleaning materials or means to accelerate the defrosting process other than those recommended by the manufacturer.
- Be aware that the refrigerant inside the system is odourless.



WARNING

The appliance shall be stored in a room without continuously operating ignition sources (example: open flames, an operating gas appliance or an operating electric heater).



NOTICE

Maintenance **MUST** be done by an authorized installer or service agent.

We recommend performing maintenance at least once a year. However, applicable legislation might require shorter maintenance intervals.



DANGER: RISK OF ELECTROCUTION

To clean the air conditioner or air filter, be sure to stop operation and turn all power supplies off. Otherwise, an electric shock and injury may result.



WARNING

To prevent electrical shocks or fire:

- Do NOT rinse the unit.
- Do NOT operate the unit with wet hands.
- Do NOT place any objects containing water on the unit.



CAUTION

After a long use, check the unit stand and fitting for damage. If damaged, the unit may fall and result in injury.



CAUTION

Do NOT touch the heat exchanger fins. These fins are sharp and could result in cutting injuries.



WARNING

Be careful with ladders when working in high places.

Following symbols may occur on the indoor unit:

Symbol	Explanation
	Measure the voltage at the terminals of main circuit capacitors or electrical components before servicing.

8.2 To clean the indoor unit and user interface



WARNING

Improper detergents or cleaning procedure may cause damage on plastic components or water leakage. Splashed detergent on electric components, such as motors, may cause failure, smoke or ignition.



NOTICE

- Do NOT use gasoline, benzene, thinner, polishing powder or liquid insecticide. **Possible consequence:** Discoloration and deformation.
- Do NOT use water or air of 40°C or higher. **Possible consequence:** Discoloration and deformation.
- Do NOT use polishing compounds.
- Do NOT use a scrubbing brush. **Possible consequence:** The surface finishing peels off.
- As an end user, you may NEVER clean inside parts of the unit by yourself; this work must be performed by a qualified service person. Contact your dealer.



DANGER: RISK OF ELECTROCUTION

Before cleaning, be sure to stop the operation, turn the breaker off or pull out the supply cord. Otherwise, an electric shock and injury may result.

- 1 Clean with a soft cloth. If it is difficult to remove stains, use water or a neutral detergent.

8.3 To clean the front panel

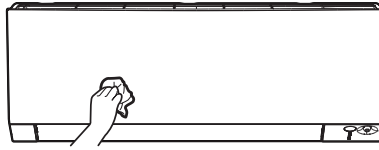

- 1 Clean the front panel with a soft cloth. If it is difficult to remove stains, use water or a neutral detergent.

8.4 To remove the front panel

- 1 Hold the front panel by the panel tabs on both sides and open it.

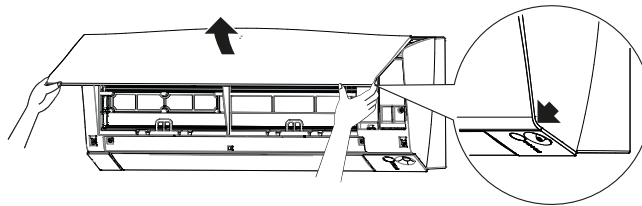

- 2 Remove the front panel by sliding it to the left or the right and pulling it toward you.

Result: The front panel shaft on 1 side will be disconnected.

- 3 Disconnect the front panel shaft on the other side in the same manner.

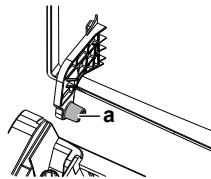

a Front panel shaft

8.5 About the air filters

Operating the unit with dirty filters means that the filter:

- CANNOT deodorise the air,
- CANNOT clean the air,
- poor heating/cooling,
- causes odour.

8.6 To clean the air filters

- 1 Push the tab at the centre of each air filter, then pull it down.
- 2 Pull out the air filters.

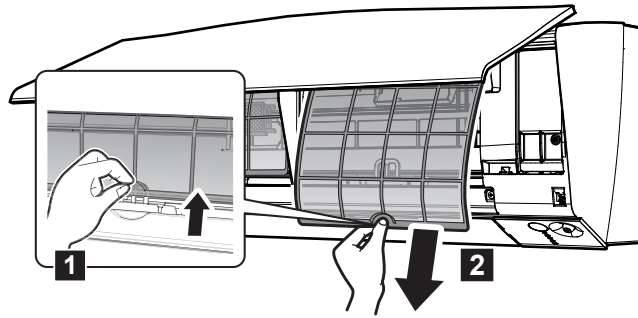

Note: (class 50~71) The titanium apatite deodorising filter and the silver allergen removal air purifying filter **MUST** be removed before cleaning the air filter.

- 3 Remove the titanium apatite deodorising filter and the silver allergen removal air purifying filter from all 4 claws.

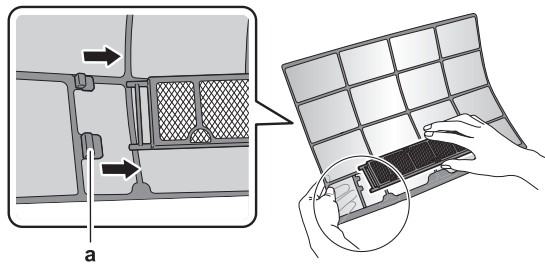

a Claw

- 4 Wash the air filters with water or clean them with a vacuum cleaner.

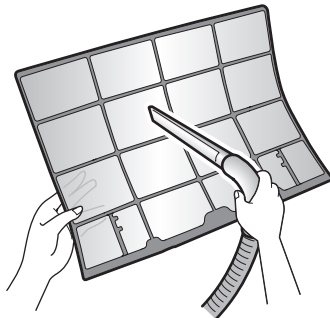

- 5 Soak in lukewarm water for about 10 to 15 minutes.

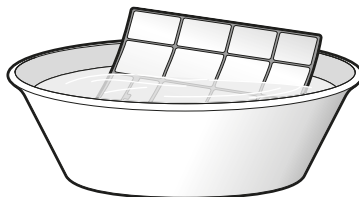

INFORMATION

- If the dust does NOT come off easily, wash them with a neutral detergent diluted in lukewarm water. Dry the air filters in the shade.
- It is recommended to clean the air filters every 2 weeks.

8.7 To clean the titanium apatite deodorising filter and the silver allergen removal air purifying filter



INFORMATION

Clean the filter with water every 6 months.

1 Remove:

- **for class 15~42:** silver allergen removal air purifying filter from the tabs

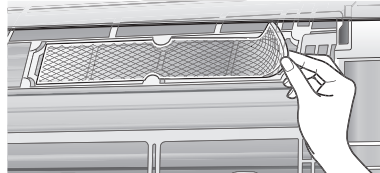

- **for class 50~71:** titanium apatite deodorising filter and the silver allergen removal air purifying filter from all 4 claws.

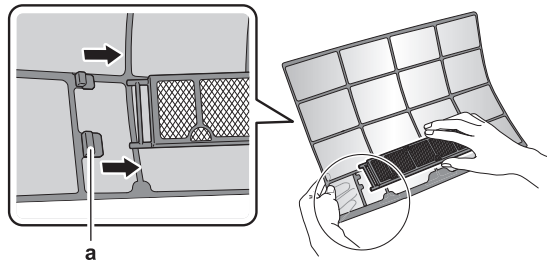

a Claw

2 Remove the dust from the filter with a vacuum cleaner.

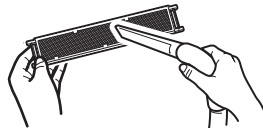

3 Soak the filter for 10 to 15 minutes in warm water.

Note: (class 50~71) Do NOT remove the filter from the frame.

Class 15~42

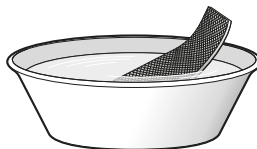

Class 50~71



4 After washing, shake off remaining water and dry the filter in the shade. Do NOT wring out the filter when removing water.

8.8 To replace the titanium apatite deodorising filter and the silver allergen removal air purifying filter



INFORMATION

Replace the filter every 3 years.

- 1 Remove the filter from the tabs (class 15~42) or frame (class 50~71) and replace the filter with a new one.

Class 15~42

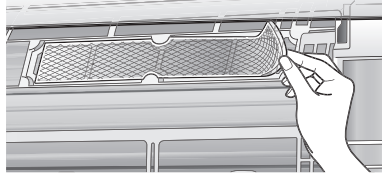

Class 50~71

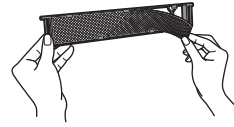

INFORMATION

- Do NOT throw away the filter frame, but use it again.
- Dispose of the old filter as non-flammable waste.

To order titanium apatite deodorising filter and the silver allergen removal air purifying filter, contact your dealer.

Item	Part number
Titanium deodorising filter - 1 set	KAF970A46
Silver allergen removal air purifying filter - 1 set	KAF057A41

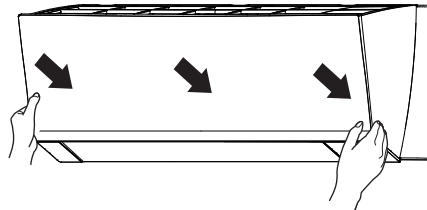

8.9 To re-install the front panel

- 1 Attach the front panel. Align the shafts with the slots and push them all the way in.
- 2 Close the front panel slowly; press at both sides and at the centre.



8.10 To take following items into account before a long idle period

Operate the unit several hours in **fan only** mode to dry the inside of the unit.

- 1 Press **Mode** and select  operation.
- 2 Press  and start operation.
- 3 After operation stops, turn the breaker off.
- 4 Clean the air filters and replace them in their original position.
- 5 Remove the batteries from the user interface.

**INFORMATION**

It is recommended to have periodical maintenance performed by a specialist. For specialist maintenance, contact your dealer. Maintenance costs shall be borne by the customer.

In certain operating conditions the inside of the unit may get dirty after several seasons of use. This results in poor performance.

9 Troubleshooting

If one of the following malfunctions occur, take the measures shown below and contact your dealer.



WARNING

Stop operation and shut off the power if anything unusual occurs (burning smells etc.).

Leaving the unit running under such circumstances may cause breakage, electric shock or fire. Contact your dealer.

The system **MUST** be repaired by a qualified service person.

Malfunction	Measure
If a safety device such as a fuse, a breaker or an earth leakage breaker frequently actuates or the ON/OFF switch does NOT properly work.	Turn OFF the main power switch.
If water leaks from the unit.	Stop the operation.
The operation switch does NOT work well.	Turn OFF the power supply.
The operation lamp flashes and you can check the error code by the user interface. To display the error code see "9.2 Solving problems based on error codes" [▶ 53].	Notify your installer and report the error code.

If the system does NOT operate properly except for the above mentioned cases and none of the above mentioned malfunctions is evident, investigate the system in accordance with the following procedures.

Malfunction	Measure
If the system does NOT operate at all.	<ul style="list-style-type: none"> ▪ Check if there is no power failure. Wait until power is restored. If a power failure occurs during operation, the system automatically restarts immediately after power is restored. ▪ Check if no fuse has blown or breaker is activated. Change the fuse or reset the breaker if necessary. ▪ Check the batteries of the user interface. ▪ Check the timer setting.
The system suddenly stops operating.	<ul style="list-style-type: none"> ▪ Check if the air inlet or outlet of the outdoor or indoor unit is NOT blocked by obstacles. Remove any obstacles and make sure the air can flow freely. ▪ The air conditioner may stop operating after sudden large voltage fluctuations to protect the system. It automatically resumes operation after about 3 minutes.
The fan will stop during airflow operation.	If the set temperature is reached, the airflow rate is reduced and operation stops. Operation will resume automatically when the indoor temperature rises or falls.
The flaps do NOT start to swing immediately.	The indoor unit is adjusting the position of the flaps. The flaps will start moving soon.

Malfunction	Measure
Operation does NOT start soon.	In case the ON/OFF button was pressed right after operation was stopped or if the mode was changed. Operation will start after 3 minutes to protect the system.
The system operates, but cooling or heating is insufficient.	<ul style="list-style-type: none"> ▪ Check the airflow rate setting. Refer to "6.4 Airflow rate" [▶ 23]. ▪ Check the temperature setting. Refer to "6.3.1 To start/stop operation mode and to set the temperature" [▶ 22]. ▪ Check if the airflow direction setting is appropriate. Refer to "6.5 Airflow direction" [▶ 23]. ▪ Check if the air inlet or outlet of the outdoor or indoor unit is NOT blocked by obstacles. Remove any obstacles and make sure the air can flow freely. ▪ Check if the air filters are clogged. Clean the air filters. See "8 Maintenance and service" [▶ 43]. ▪ Check for open doors or windows. Close doors and windows to prevent wind from coming in. ▪ Check if the unit operates in Econo or Outdoor unit quiet operation. Refer to "6.8 Econo and Outdoor unit quiet operation" [▶ 27]. ▪ Check if there is any furniture directly under or next to the indoor unit. Move the furniture.
The system operates, but heating is insufficient (air is NOT blown from the unit).	<ul style="list-style-type: none"> ▪ The air conditioner may be warming up for heating operation. Wait for 1 to 4 minutes. ▪ If a flowing sound is heard, the outdoor unit may be in defrost operation. Wait for 4 to 12 minutes.
The ON/OFF timer does NOT operate according to the settings.	<ul style="list-style-type: none"> ▪ Check if the Weekly timer and ON/OFF timer are set to the same time. Change or deactivate the setting. Refer to "6.10 OFF/ON timer operation" [▶ 29] and "6.11 Weekly timer operation" [▶ 30]. ▪ Check if the clock and the day of the week are set correctly. Refer to "5.4 About the clock" [▶ 18].
Cooling operation CANNOT be selected.	Check if your system is NOT heating only version.
An abnormal function happens during operation.	The air conditioner may malfunction because of lightning or radio waves. Turn the breaker OFF and back ON.
The unit does NOT receive signals from the user interface.	<ul style="list-style-type: none"> ▪ Check the batteries of the user interface. Refer to "5.2 To insert the batteries" [▶ 17]. ▪ Make sure that the transmitter is NOT exposed to direct sunlight. ▪ Check if there are any electronic starter type fluorescent lamps in the room. Contact your dealer.

Malfunction	Measure
The user interface display is blank.	Replace the batteries of the user interface.
An error code can be displayed on the user interface.	Consult your local dealer. Refer to " 9.2 Solving problems based on error codes " [▶ 53] to procedure how to display the error code and for a detailed list of error codes.
Other electric appliances start to operate.	If the user interface signals operate other electric appliances, move the other appliances away, and contact your dealer.

If after checking all above items, it is impossible to fix the problem yourself, contact your installer and state the symptoms, the complete model name of the unit (with manufacturing number if possible) and the installation date (possibly listed on the warranty card).

9.1 Symptoms that are NOT system malfunctions

The following symptoms are NOT system malfunctions:

9.1.1 Symptom: A sound like water flowing is heard

- This sound is caused by the refrigerant flowing in the unit.
- This sound may be generated when water is flowing away from the unit during cooling or drying operation.
- The refrigerant flows in the air conditioner even if the indoor unit is turned off and an indoor unit in another room is operating.

9.1.2 Symptom: A blowing sound is heard

This sound is generated when the direction of the refrigerant flow is changed (e.g. when switching from cooling to heating).

9.1.3 Symptom: A ticking sound is heard

This sound is generated when the unit slightly expands or contracts with changes in temperature.

9.1.4 Symptom: A whistling sound is heard

This sound is generated by the refrigerant flowing during defrost operation.

9.1.5 Symptom: A clicking sound during operation or idle time is heard

This sound is generated when the refrigerant control valves or electrical parts operate.

9.1.6 Symptom: A clapping sound is heard

This sound is generated when an external device sucks air out of the room (e.g. exhaust fan, extractor hood) while the doors and windows in the room are closed. Open the doors or windows, or turn off the device.

9.1.7 Symptom: White mist comes out of a unit (Indoor unit, outdoor unit)

When the system is changed over to heating operation after defrost operation. Moisture generated by defrost becomes steam and is exhausted.

9.1.8 Symptom: The units can give off odours

The unit can absorb the smell of rooms, furniture, cigarettes, etc., and then emit it again.

9.1.9 Symptom: The outdoor fan rotates while the air conditioner is not in operation

- **After operation has stopped.** The outdoor fan continues to rotate for another 30 seconds for system protection.
- **While the air conditioner is not in operation.** When the outdoor temperature is very high, the outdoor fan starts to rotate for system protection.

9.1.10 Symptom: Indoor unit fan speed does not correspond with the setpoint (during low ambient cooling operation in Multi system)

- During low ambient cooling operation in Multi system, indoor unit may change fan speed to high regardless of the user setting to defrost the indoor unit heat exchanger.

9.2 Solving problems based on error codes

Fault diagnosis by user interface

If the unit runs into a problem, you can identify the fault by checking the error code by the user interface. It is important to understand the problem and take measures before resetting the error code. This should be done by a licensed installer or your local dealer.





INFORMATION

See the service manual for:

- The complete list of error codes
- A more detailed troubleshooting guideline for each error

To check the error code by the user interface

- 1 Aim the user interface at the unit and press  for about 5 seconds.
Result:  blinks in the temperature setting display section.
- 2 Aim the user interface at the unit and press  repeatedly until a continuous beep is heard.
Result: The code is now displayed on the display.

**INFORMATION**

- A short beep and 2 consecutive beeps indicate non-corresponding codes.
- To cancel the code display, hold **Cancel** for 5 seconds. The code will also disappear from the display if the button is NOT pressed within 1 minute.

System

Error code	Description
00	Normal
U0	Refrigerant shortage
U2	Overvoltage detection
U3	Malfunction of transmission
U4	Signal transmission error (between indoor and outdoor unit)

Indoor unit

Error code	Description
R1	Indoor unit PCB abnormality
R5	Freeze-up protection or high-pressure control
R6	Fan motor (DC motor) abnormality
L4	Indoor heat exchanger thermistor abnormality
L9	Room temperature thermistor abnormality

Outdoor unit

Error code	Description
ER	4-way valve abnormality
E1	Outdoor unit PCB abnormality
E3	Actuation of high pressure switch (HPS)
E5	Overload activation (compressor overload)
E6	Compressor lock
E7	DC fan lock
F3	Discharge pipe temperature control
H3	Malfunction of high pressure switch (HPS)
H6	Position sensor abnormality
H8	DC voltage / current sensor abnormality
H9	Outdoor temperature thermistor abnormality
J3	Discharge pipe thermistor abnormality
J6	Outdoor heat exchanger thermistor abnormality
L4	Radiation fin temperature rise
L5	Inverter instantaneous overcurrent (DC)
P4	Radiation fin thermistor abnormality

9.3 Troubleshooting for wireless LAN connection

The following table provides a brief description of how to deal with some problems. If none of the following solutions fix the problem, go to <http://www.onlinecontroller.daikineurope.com/> for more information and FAQ.

Problem	Measure
Connection to the wireless LAN is not possible (none of the LEDs on the indoor unit display are blinking).	<ul style="list-style-type: none"> ▪ Try operating the unit with the user interface. ▪ Check if the power is on. ▪ Turn the unit off and back on again.
The wireless LAN is NOT visible on the unit overview screen (Home screen) after configuration of the WLAN adapter (WPS option).	<ul style="list-style-type: none"> ▪ Make sure the wireless LAN is close enough to the communication device. ▪ Check if communication is OK. ▪ Make sure that the smart device is connected to the same wireless network as the wireless LAN. ▪ Try resetting to the factory default and repeat the setting. See "To reset the connection setting to the factory default" [▶ 37].
The wireless LAN is NOT visible in the available Wi-Fi networks list on the smart device (Access point option).	<ul style="list-style-type: none"> ▪ Try switching between access point and WPS setting to change the wireless channel. The wireless channel MUST be between 1~13. ▪ Check if communication is OK. ▪ Try resetting to the factory default and repeat the setting. See "To reset the connection setting to the factory default" [▶ 37].
Displayed indoor/outdoor temperature value in Daikin Residential Controller differs from the value measured by other appliances.	<ul style="list-style-type: none"> ▪ Daikin Residential Controller displays indoor/outdoor temperature only for the indoor/outdoor unit's surrounding. ▪ Measured temperature for other appliances may differ due to different condition around the unit (e.g. direct sunlight, frost accumulation...) ▪ Temperature displayed in Daikin Residential Controller is only referential.

10 Disposal



NOTICE

Do NOT try to dismantle the system yourself: dismantling of the system, treatment of the refrigerant, oil and other parts **MUST** comply with applicable legislation. Units **MUST** be treated at a specialised treatment facility for reuse, recycling and recovery.

11 Glossary

Dealer

Sales distributor for the product.

Authorised installer

Technical skilled person who is qualified to install the product.

User

Person who is owner of the product and/or operates the product.

Applicable legislation

All international, European, national and local directives, laws, regulations and/or codes that are relevant and applicable for a certain product or domain.

Service company

Qualified company which can perform or coordinate the required service to the product.

Installation manual

Instruction manual specified for a certain product or application, explaining how to install, configure and maintain it.

Operation manual

Instruction manual specified for a certain product or application, explaining how to operate it.

Accessories

Labels, manuals, information sheets and equipment that are delivered with the product and that need to be installed according to the instructions in the accompanying documentation.

Optional equipment

Equipment made or approved by Daikin that can be combined with the product according to the instructions in the accompanying documentation.

Field supply

Equipment NOT made by Daikin that can be combined with the product according to the instructions in the accompanying documentation.





ERC

DAIKIN EUROPE N.V.

Zandvoordestraat 300, B-8400 Oostende, Belgium

DAIKIN INDUSTRIES CZECH REPUBLIC s.r.o.

U Nové Hospody 1/1155, 301 00 Plzeň Skvrňany, Czech Republic

DAIKIN ISITMA VE SOĞUTMA SİSTEMLERİ SAN.TİC. A.Ş.

Gülsuyu Mahallesi, Fevzi Çakmak Caddesi, Burçak Sokak, No:20, 34848 Maltepe

İSTANBUL / TÜRKİYE

Tel: 0216 453 27 00

Faks: 0216 671 06 00

Çağrı Merkezi: 444 999 0

Web: www.daikin.com.tr

Copyright 2020 Daikin

4P518786-5F 2020.06